

Flexi Support

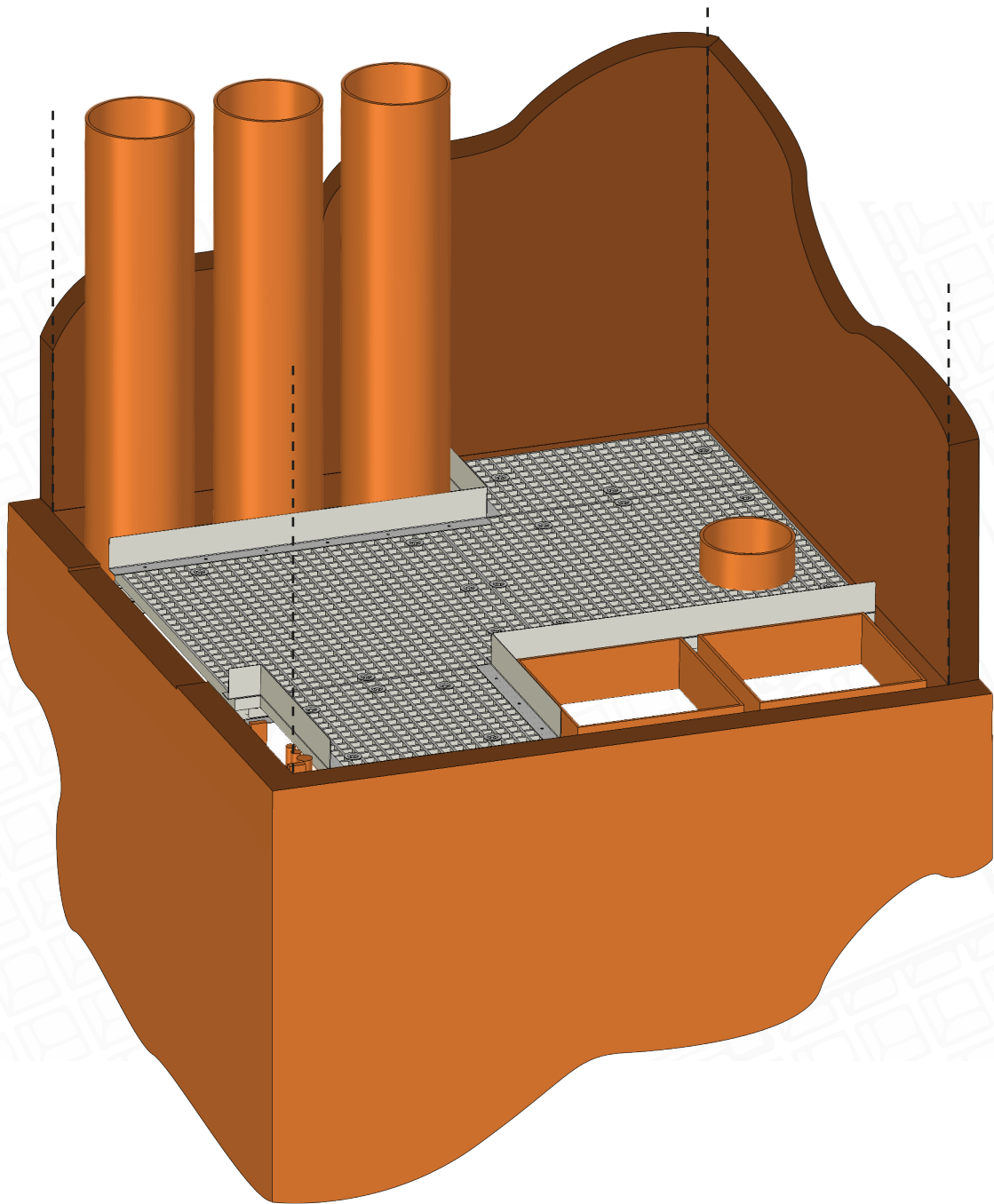

Flexible and adjustable support system for use in service shafts



Product

Flexi Support

The perfect solution for service shafts

The **Flexi Support** system is an adjustable and flexible support system that can be easily and quickly adapted to the internal dimensions of the shaft as well as pipe installations. The system is designed to address the challenges associated with installations in service shafts. The product has documented structural design and static calculations in accordance with the requirements of SBI 271 and DS 1140.

The system includes:

- **U-profiles:** Two U-profiles with slotted holes, assembled with bolts and nuts to form a solid H-profile
- **Fixing:** The adjustable profiles are fixed to the sides of the shaft with angles, as well as at locations where trimmers are required
- **GRP gratings:** The gratings are easily cut to size, placed on top of the support system, and installed with fixing material. A major advantage of GRP-grating is its resistance to corrosion
- **Kick plates and guardrails:** Bent steel plates used as kick plates, along with a flexible guard-rail system for additional safety



SBI-An



DS

DANSK STANDARD

Problem & solution

Service shafts and pipe installations are rarely identical – from project to project, from shaft to shaft, and even from floor to floor.

Previous experience shows that when using traditional support systems and steel gratings in galvanized steel, installation costs become high and lead times long, as they must be measured and manufactured before installation.



Flexi Support - above

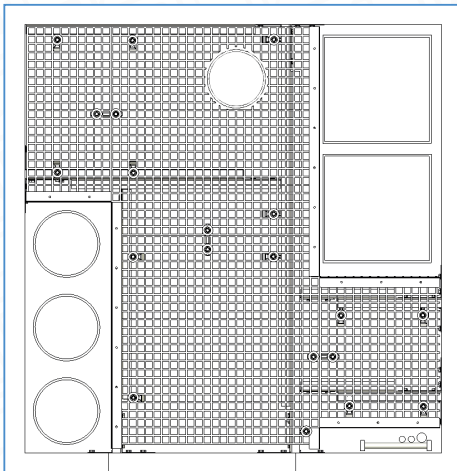

Flexi Support - below

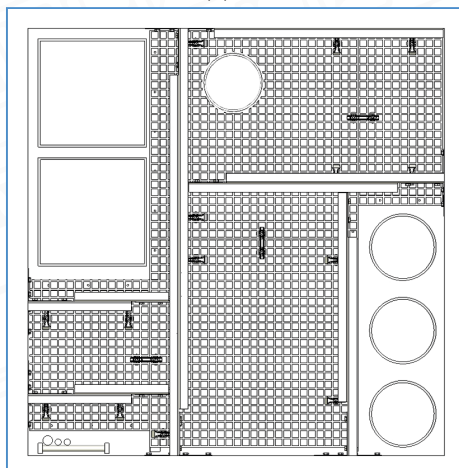

Flexi Support

The system is developed to handle these challenges.

Quick and easy installation

Thanks to its adjustable design, the system can be quickly adapted to different shaft sizes and pipe installations.

High strength and flexibility

The high strength of the GRP-grating and its ease of cutting—without the need for additional finishing—make installation efficient and straightforward. A jigsaw is recommended, as it does not generate large amounts of dust.

Installation

- The profiles are extended and assembled using angles and bolts
- The GRP-grating is placed on top of the profiles, cut to size if necessary, and fixed with the associated fixing material
- If additional rigidity between gratings is required, a double clamp fixing can be installed
- Kick plates can be installed where required. This is necessary, in accordance with DS/EN ISO 14122, if the gap between the platform and the structure exceeds 30 mm
- Guardrails can also be supplied as fall protection if required

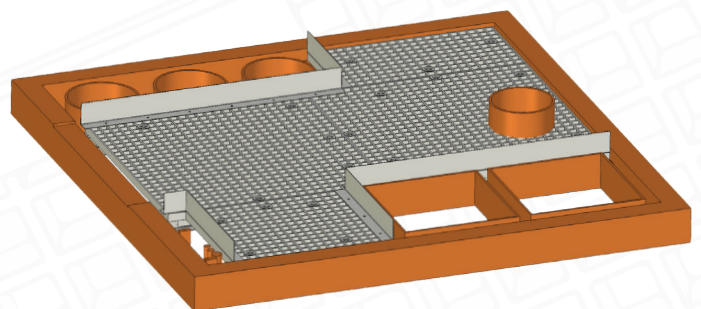
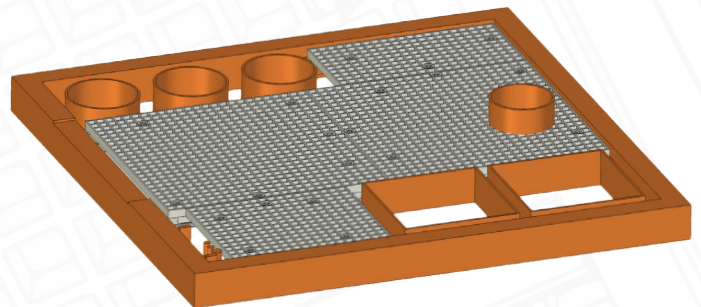
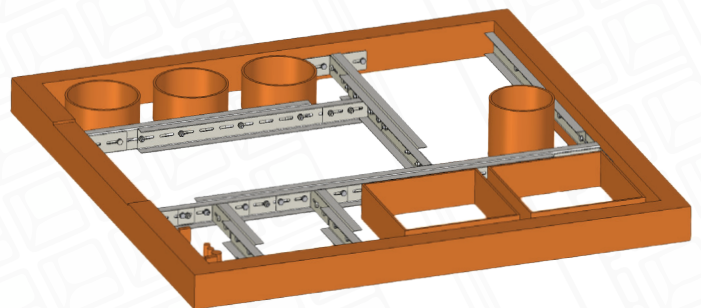
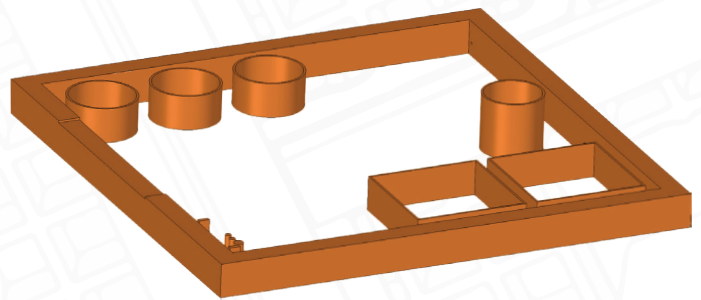

Components

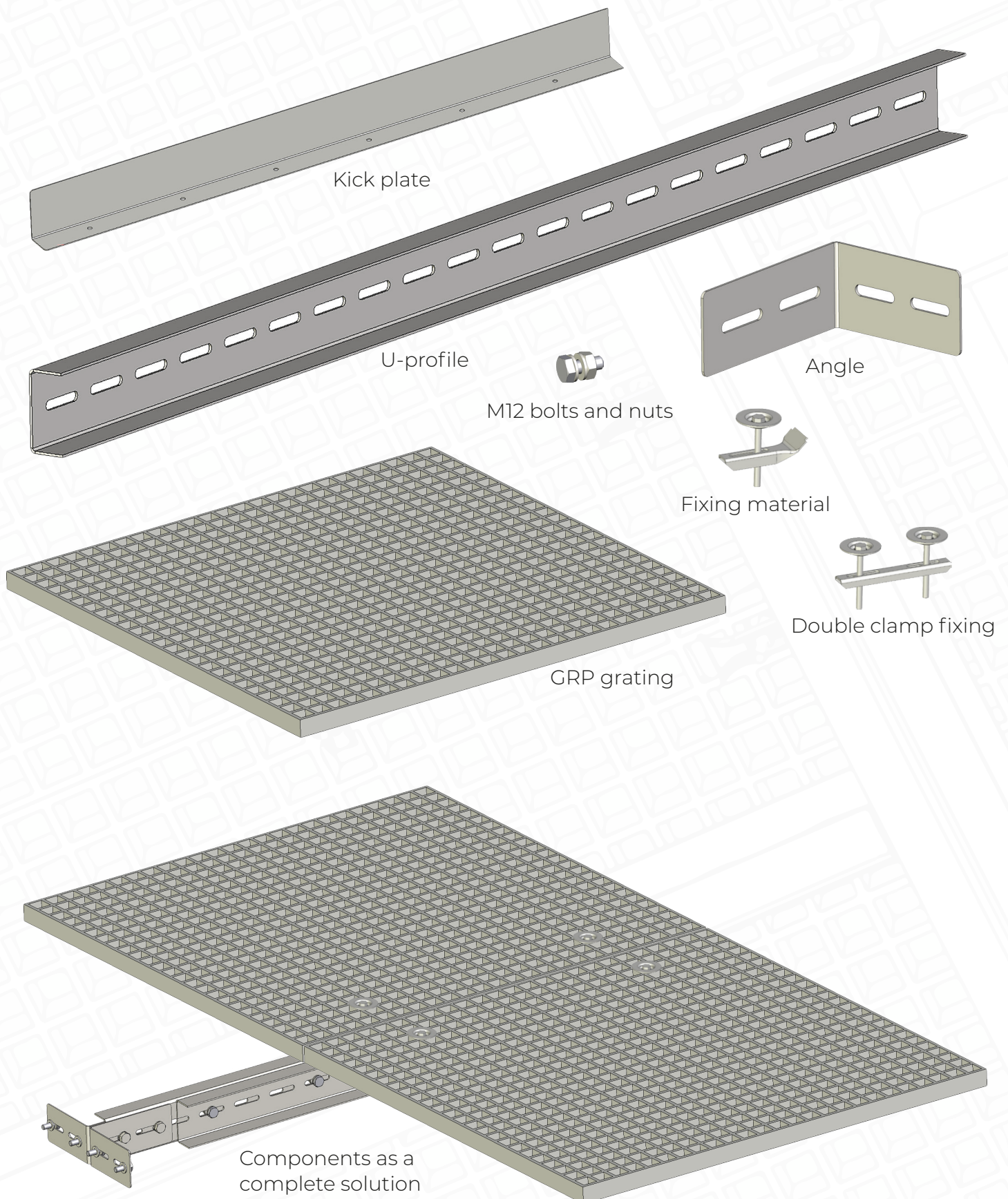

Advantages

01

The use of the Flexi Support system is a quick and easy solution that saves time and money

03

Grating cutting, adjustment, and installation ensure rapid completion of the project

05

Documented structural design and static calculations for the Flexi Support system in accordance with the requirements of SBI 271 and DS 1140

02

Measurement of profiles, cutting, and installation carried out in a single operation on site

04

Option for custom-made brackets, trimmers, and profiles for use with extra large spans

“

Discover the benefits of the **Flexi Support** system and make your technical installations more flexible and efficient.

Contact us for more information or **non-binding advice**

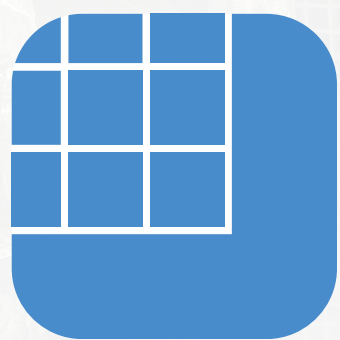

**FLEXI
RISTE**

Hjejlevej 10 - 7480 Vildbjerg

Tlf. +45 97 13 32 11

mail@flexiriste.dk